

GENERATION





L

LEADERS

For those who are **leaders on and off the court.**

They perfectly **manage emotions** and have a great ability to **determine their goals** and objectives.

They **help** those at their side to **achieve success.**

Free, nonconformist, **creative spirits** and they **don't follow the rules...**

They play sports to have fun, release themselves and go beyond.

Padel is the time of the day where they feel free and fulfilled.

OUTSIDERS

S



KINGS

The **kings of the court.**

Strong personalities, with **cheeky attitudes.**

They take the initiative, they like to feel like **protagonists.**

“The brand of the next generation of players”

K





MANIFESTO

WE ARE BORN OUT OF EMOTION, ENERGY AND OUR **PASSION** FOR PADEL. OUR **ACCENT** STANDS FOR PLAYERS FROM ALL OVER THE WORLD WHO SHARE THE SAME **VALUES**.

WE SEEK NEW **CHALLENGES** ON A DAY TO DAY BASIS. LOOKING AHEAD, ENJOYING AND CELEBRATING EVERY MOMENT, **EVERY POINT**. IF YOU LIKE TO **TAKE RISKS** **ON** AND **OFF** THE COURT, YOU ARE **ONE OF US**.

TO NEW STORIES TO TELL, **EXPERIENCE** TO LIVE, AND MEMORIES TO CHERISH. WE ARE MORE THAN READY TO WHAT'S **COMING** NEXT!!!

HARDWARE

 **HYPE** | ATTACK AND NEVER LOOK BACK



FOR AGGRESSIVE PLAYERS WITH BOLD ATTITUDE & POWERFUL PLAY THAT DON'T HESITATE TO TAKE THE INITIATIVE AND RESPONSIBILITY AND ARE FEARLESS TO ACCELERATE THE BALL TO HIT WINNERS

 **FLOW** | KEEP CALM & LET IT FLOW



FOR THOSE PLAYERS WITH TOUCH AND FINESSE PLAY THAT SLOWLY COOK THE POINT WITH MEASURED & CONTROLLED SHOTS AND TAKE OUT THEIR OPPONENTS WITH PRECISION

FIBERS

In the *Generation TWO* collection we work the carbon in **three different planes**. Thanks to this technology we can adjust the **bond angles** of the fiber layers to achieve the right flexibility.

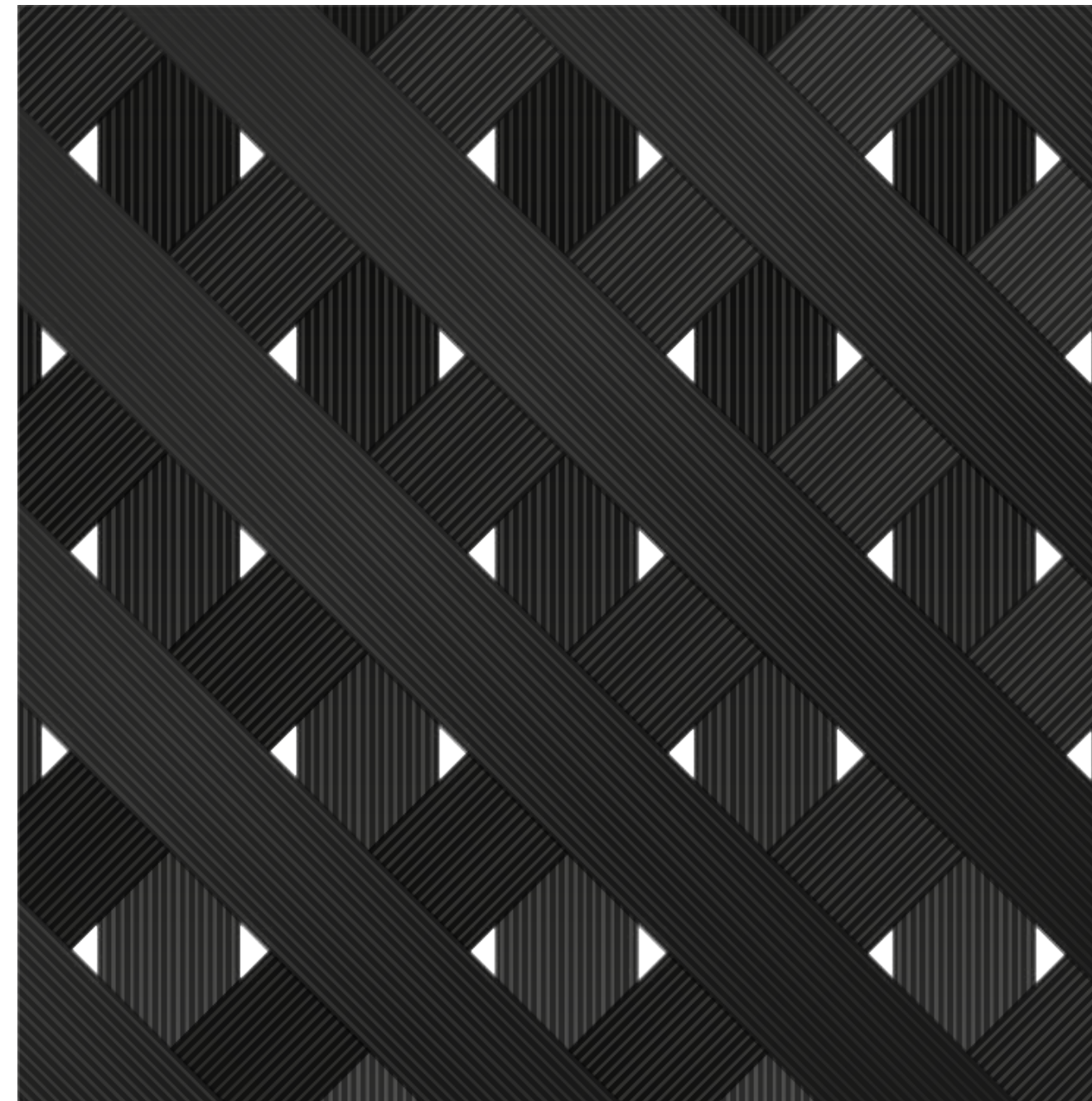
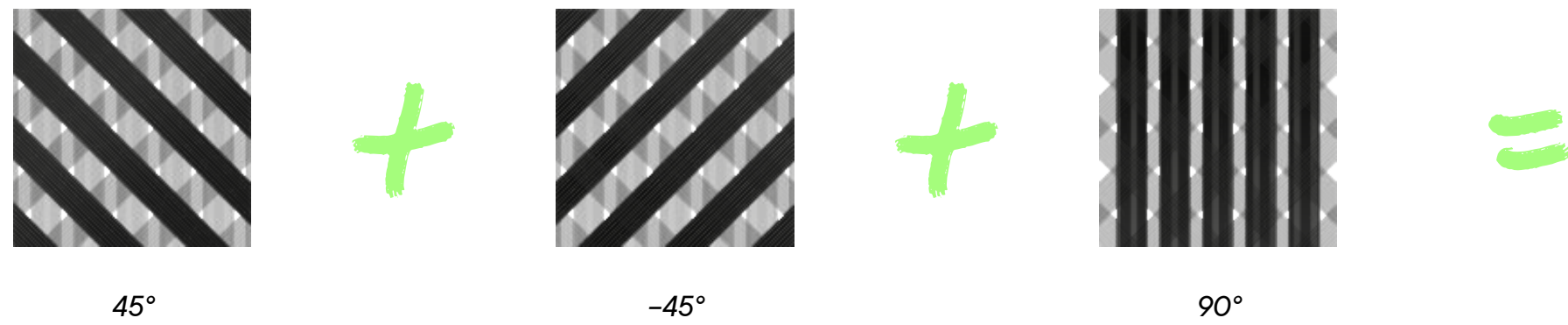

Carbon interlaced in 3 overlapping layers

C18 CARBON
MAXX

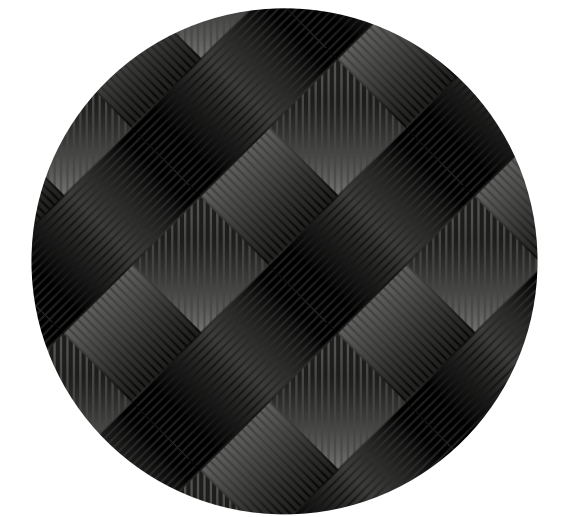

C6 CARBON
CARB-ON

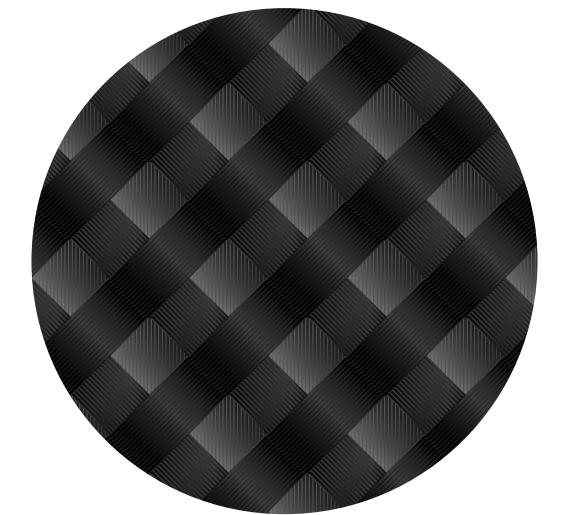

FLEX FIBER
EASY, BE

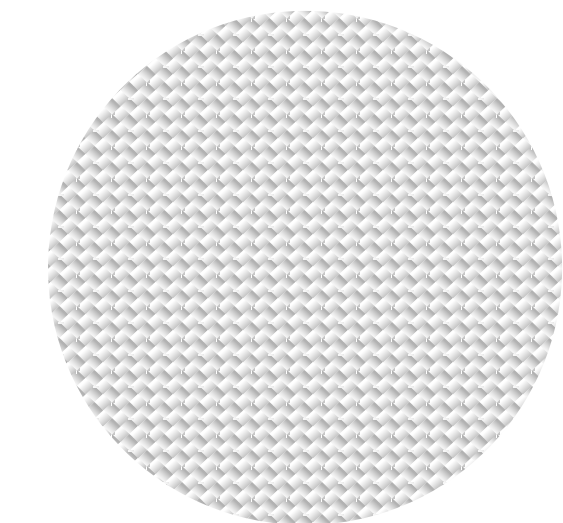



CUSTOM EVA



CUSTOM EVA

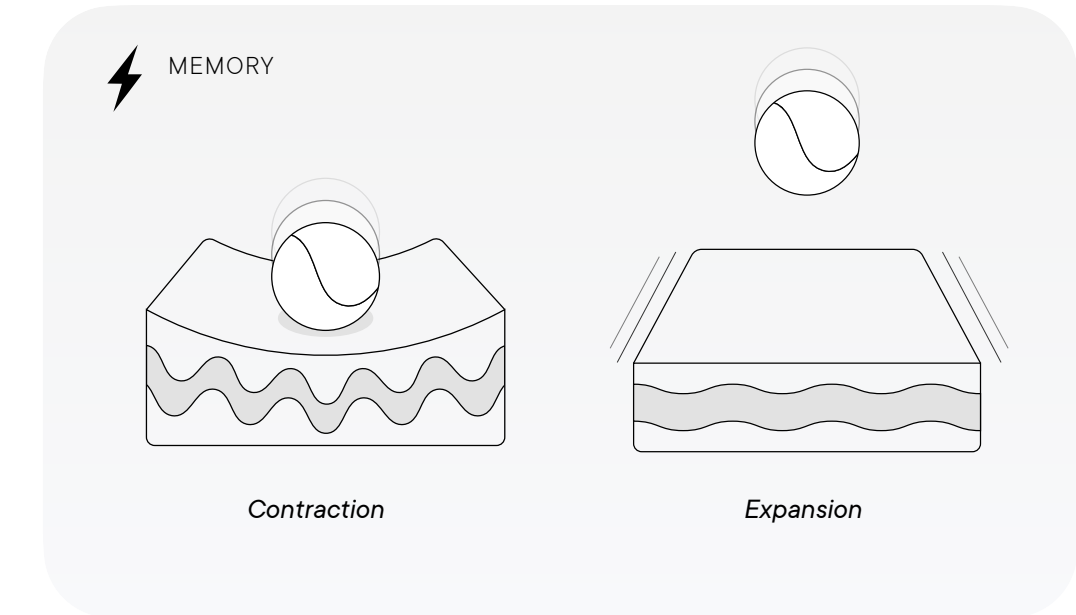

Our *Generation TWO* rackets have a **unique rubber** that has an **excellent memory capacity**, which helps the player to obtain greater power at the moment of impact.

Memory is the ability of the rubber to recover its initial position in a shorter time after a ball impact. Thanks to its density, this rubber adapts to any player.

**NEW BLACK
RUBBER**



ASYMMETRIC HEART

Our heart is the emblem of our rackets and is distinguished by its **asymmetrical design** while maintaining a **perfect balance**.

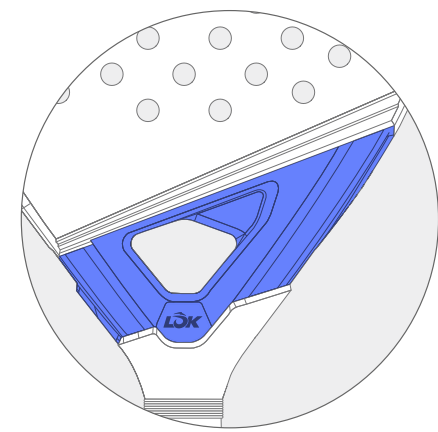

MAXX

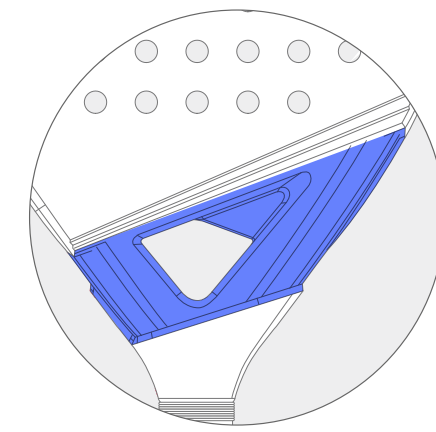

CARB-ON
EASY



NEW HEART!
BE

We have four different types of hearts depending on the models in the collection.

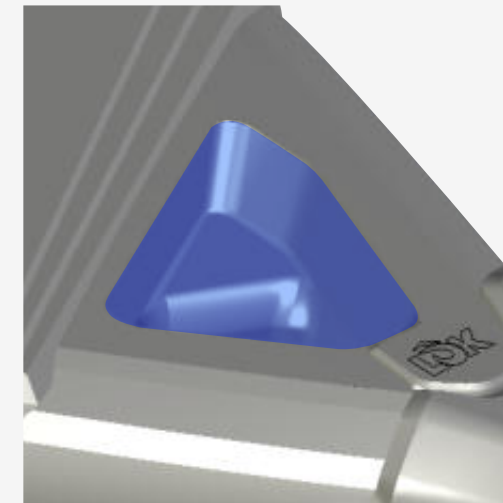

Its unique and original shape creates some **lateral steps** that form the **nerve** of the heart, offering a structural rigidity that provides stability and is key to achieving optimal balance.

Among other features, *Asymmetric Heart* allows increasing the speed of the ball in the swing by giving more power to the shot.

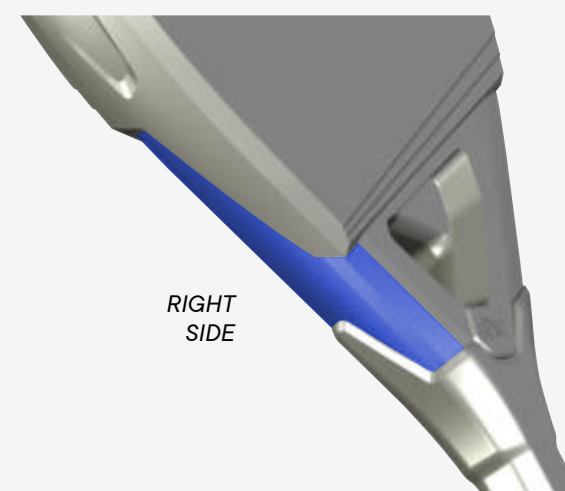

RIGHT
SIDE

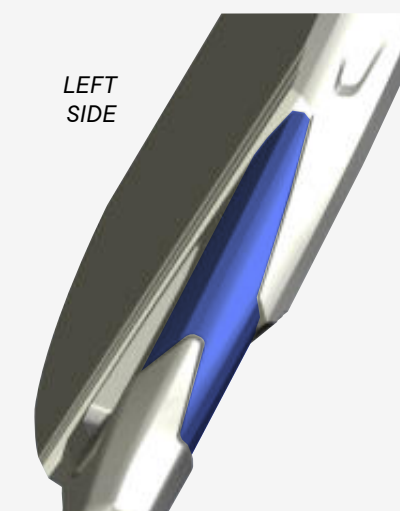

LEFT
SIDE

JUNGLE NEW ASYMMETRIC HEART

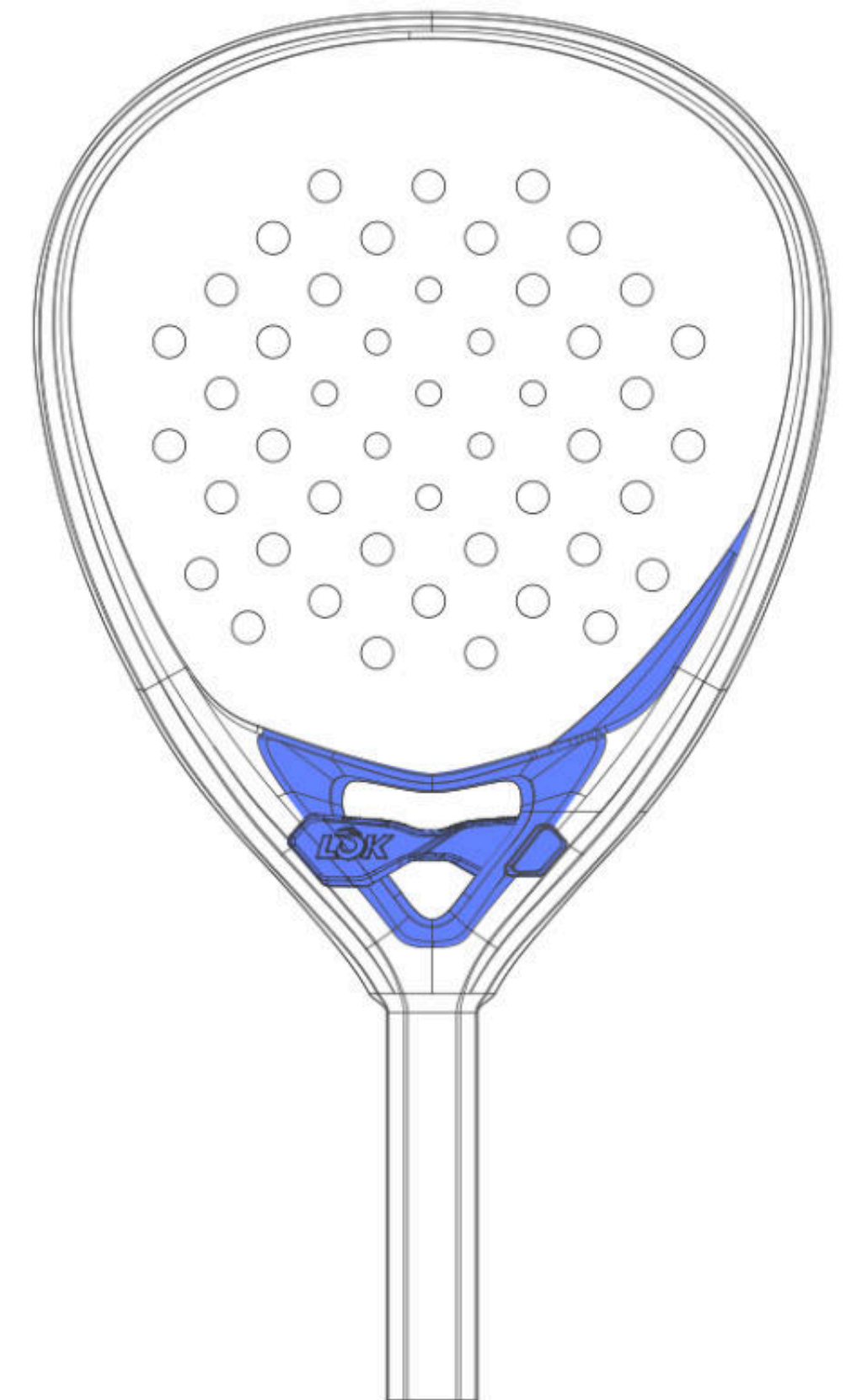

GRADUAL FACE

Our rackets have a system of **stepped layers** generated in the upper and lower parts of the faces.

Gradual Face are steps and reliefs that generate angles that will help reduce vibration as it moves across the entire surface at the moment of impact.

This vibration is produced from the point of impact moving to both the top and bottom of the face, places where the technology is present.

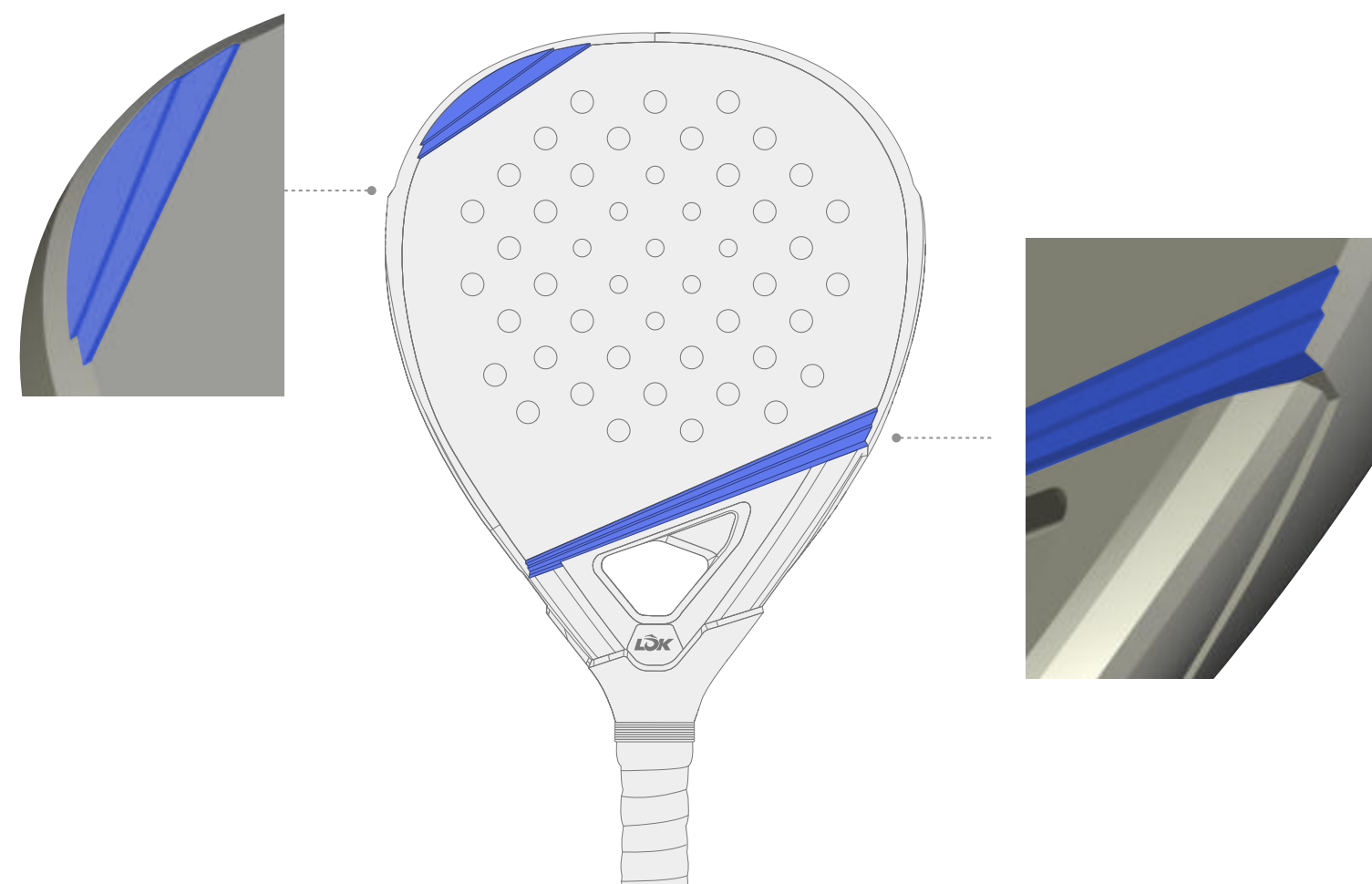

New 3D SPIN LINES

The *3D Spin Lines* system increases the rotation of the ball when it impacts the racket, thus increasing spin and improving the feeling of control.

It consists of a system of squares and wave lines angles to improve the sensation of handling.

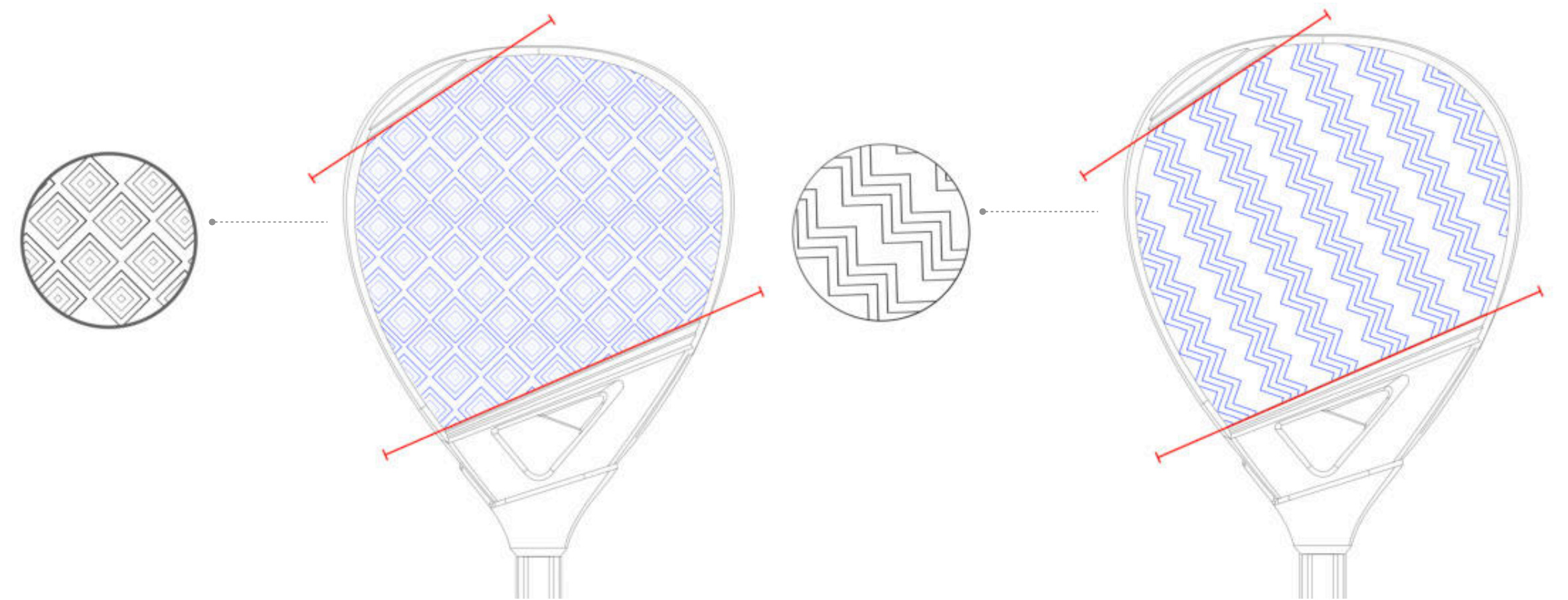

DYNAMIC HOLES SYSTEM

A progressive layout with two different hole sizes -10 and 11mm- in the central part of the face to help power the shot.

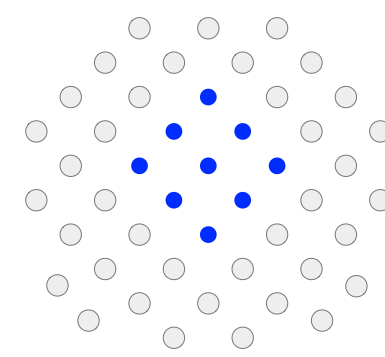

MAXX

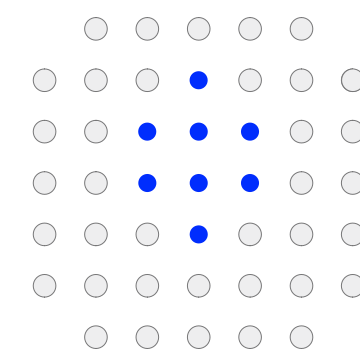

CARB-ON

VIBRATION GROOVE

Rail inserted in the frame of the blade to help dissipate vibrations caused by the impact of the ball. The rail incorporates a PU finish to maximize its function.

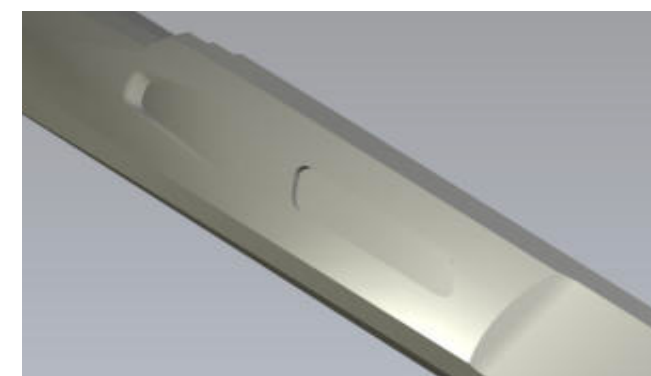
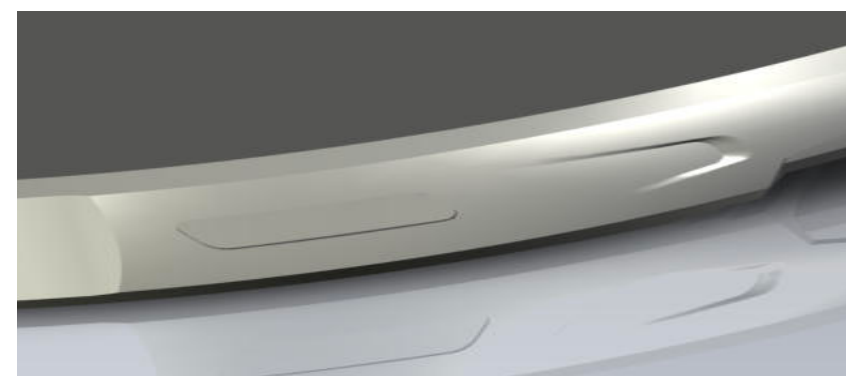

COMFORT WRISTBAND

The racket has an adjustable wrist strap that accompanies the string to provide comfort in the grip, whatever the necessities and preferences of the player.

It has a reinforced layer and a softened inner part for maximum comfort, and a design with the brand's claim.



CARBON REINFORCEMENT

Carbon reinforcements in different critical points of the racket as structural support to contribute to durability.

RACQUETS



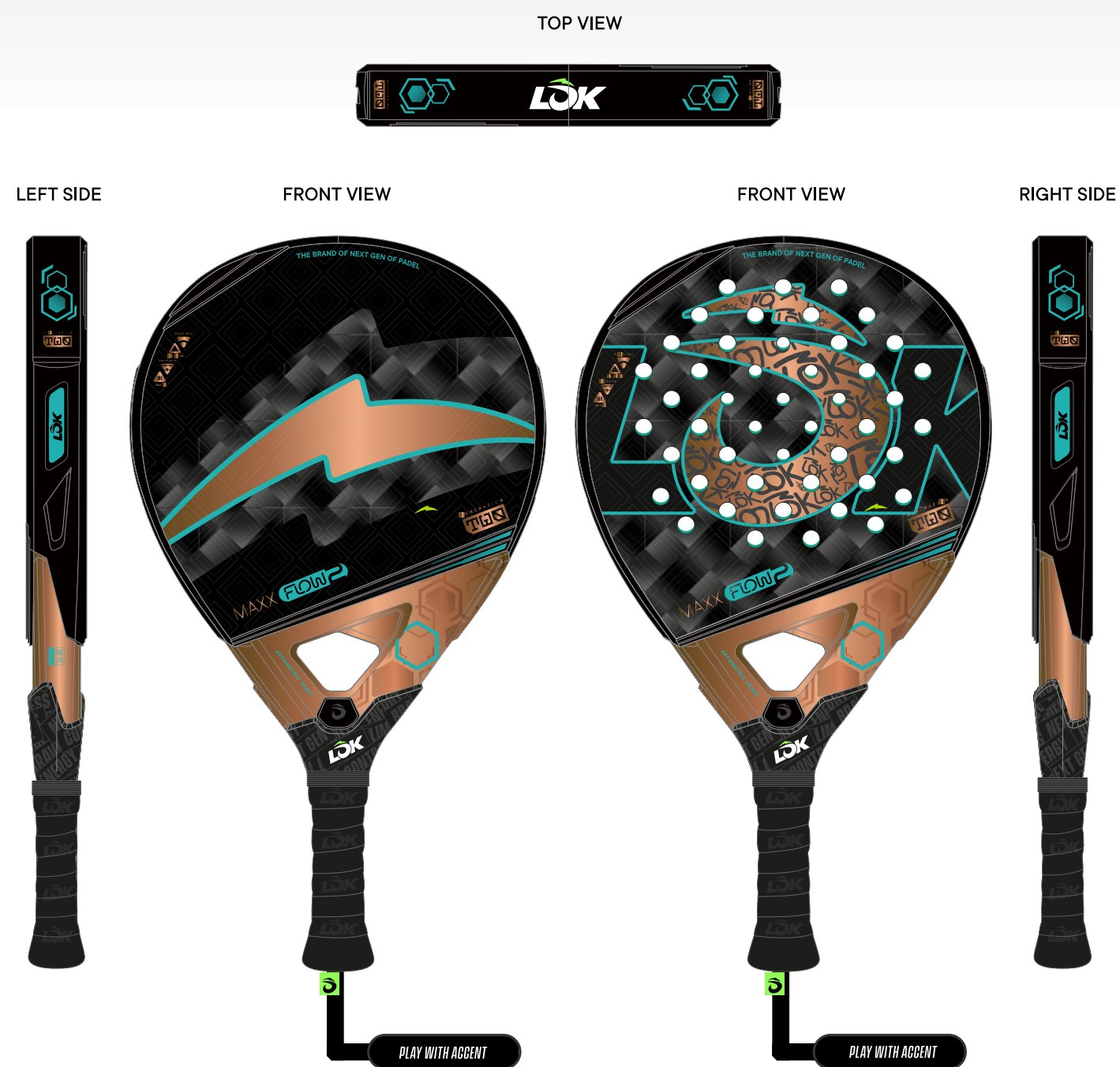

GRADUAL FACE
VIBRATION GROOVE
DYNAMIC HOLE SYSTEM
3D SPIN PATTERN
CARBON REINFORCEMENT
ASYMMETRIC HEART



- ROUND HEAD
- CUSTOM EVA
- SWEET SPOT CENTER
- 18K CARBON

- MAXX TIER
- MAXX TECH
- MAXX LEVEL
- MAXX QUALITY

TECHNICAL SHEET

LEVEL: PRO
SWEET SPOT: CENTER
SHAPE: ROUND
BALANCE: CENTER
WEIGHT: 360-375 gr
LENGTH / THICKNESS: 455 / 38 mm

MATERIALS

FRAME: CARBON
SURFACE: CARBON C18
E.V.A.: CUSTOM EVA

REFERENCE LR1FAOU73
EAN 8435739406113

COMFORT WRISTBAND



RACKETS

CARB-ON HYPE2

FRANCO DAL BIANCO

GENERATION



LEFT SIDE

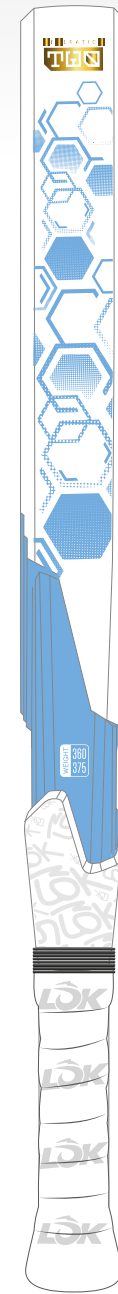

TOP VIEW



FRONT VIEW



RIGHT SIDE

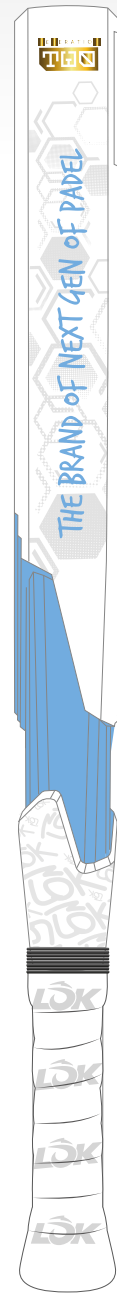

GRADUAL FACE

DYNAMIC HOLE SYSTEM

3D SPIN PATTERN

CARBON REINFORCEMENT

ASYMMETRIC HEART

DIAMOND HEAD



6K

CARBON

SWEET SPOT



CUSTOM EVA

C6 CARB-ON

ON-ANGLES

ON-QUALITY

ON-FELXIBILITY

TECHNICAL SHEET

LEVEL: ADVANCED
SWEET SPOT: TOP
SHAPE: DIAMOND OVERSIZE
BALANCE: TOP
WEIGHT: 360-375 gr
LENGHT / THICKNESS: 455 / 38 mm

MATERIALS

FRAME: CARBON
SURFACE: CARBON C6
E.V.A.: CUSTOM EVA

CARB-ON

REFERENCE

LR2HA1U74

EAN

8435739406144

COMFORT WRISTBAND



PLAY WITH ACCENT

PLAY WITH ACCENT

PLAY WITH ACCENT

RACKETS
JUNGLE

LEFT SIDE



FRONT VIEW



RIGHT SIDE



TECHNICAL SHEET

LEVEL: PRO
SWEET SPOT: TOP
SHAPE: DIAMOND OVERSIZE
BALANCE: TOP
WEIGHT: 360-375 gr
LENGTH / THICKNESS: 455 / 38 mm

MATERIALS

FRAME: CARBON
SURFACE: CARBON C18
E.V.A.: CUSTOM EVA

REFERENCE LR1HA2U10
EAN 8435739406205

DYNAMIC HOLE SYSTEM

3D SPIN PATTERN

CARBON REINFORCEMENT

ASYMMETRIC HEART
HEART NERVE

COMFORT WRISTBAND



DIAMOND HEAD



18K
CARBON

SWEET SPOT
TOP



CUSTOM EVA

JUNGLE

RACKETS
JUNGLE
LITE

GENERATION
TGN

LEFT SIDE



FRONT VIEW



RIGHT SIDE



EQUAL HOLE SYSTEM

CARBON REINFORCEMENT

ASYMMETRIC HEART
 HEART NERVE

DIAMOND HEAD



FLEX FIBER

SWEET SPOT



CUSTOM EVA

TECHNICAL SHEET

LEVEL: INTERMEDIATE
 SWEET SPOT: TOP
 SHAPE: DIAMOND OVERSIZE
 BALANCE: TOP
 WEIGHT: 360-375 gr
 LENGTH / THICKNESS: 455 / 38 mm

MATERIALS

FRAME: MIXED CARBON
 SURFACE: FLEX FIBER
 E.V.A.: CUSTOM EVA

REFERENCE LR3HA1U21
 EAN 8435739406212

COMFORT WRISTBAND

JUNGLE



PLAY WITH ACCENT

PLAY WITH ACCENT

PLAY WITH ACCENT



- GRADUAL FACE
- VIBRATION GROOVE
- DYNAMIC HOLE SYSTEM
- 3D SPIN PATTERN
- CARBON REINFORCEMENT
- ASYMMETRIC HEART

TECHNICAL SHEET

LEVEL: PRO
 SWEET SPOT: TOP
 SHAPE: DIAMOND OVERSIZE
 BALANCE: TOP
 WEIGHT: 360-375 gr
 LENGHT / THICKNESS: 455 / 38 mm

MATERIALS

FRAME: CARBON
 SURFACE: CARBON C18
 E.V.A.: CUSTOM EVA

REFERENCE LR1HA3U10
 EAN 8435739407868

COMFORT WRISTBAND

DIAMOND HEAD

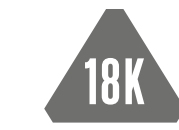

18K CARBON

SWEET SPOT



TOP



CUSTOM EVA

- MAXX TIER
- MAXX TECH
- MAXX LEVEL
- MAXX QUALITY



B
BA
BAG
BAGS



Racket Bag MAXX GEN2

Model: Black Orange

MATERIALS

Nylon 300D x2 PU Coating
Rough TPE Backing

TECHNICAL DATA

DIMENSIONS 38 x 62 x 30 cm
CAPACITY 70L
COLORS Black, grey and orange

REFERENCE LB1PAOU16

EAN 8435739406625



Racket Bag ONE GEN2

Model: Black Fluor Print

MATERIALS

PES 600D

TECHNICAL DATA

DIMENSIONS 56 x 18 x 42 cm
CAPACITY 35L
COLORS Black, grey and green lime

REFERENCE LB2PA1U27

EAN 8435739406687



AACCEESSODOARIESS



SET OF 60 OVERGRIPS

REFERENCE AC1TA0WH

EAN 8436548249533

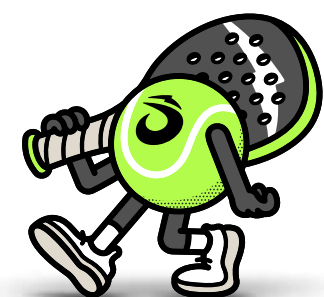

GENERATION



JOIN THE MOVEMENT

